

Article number: 2310310261ESD

Description: E+G Antistatic base for levelling elements
LV.A-125-24-AS-M16x158-ESD-C

Measures

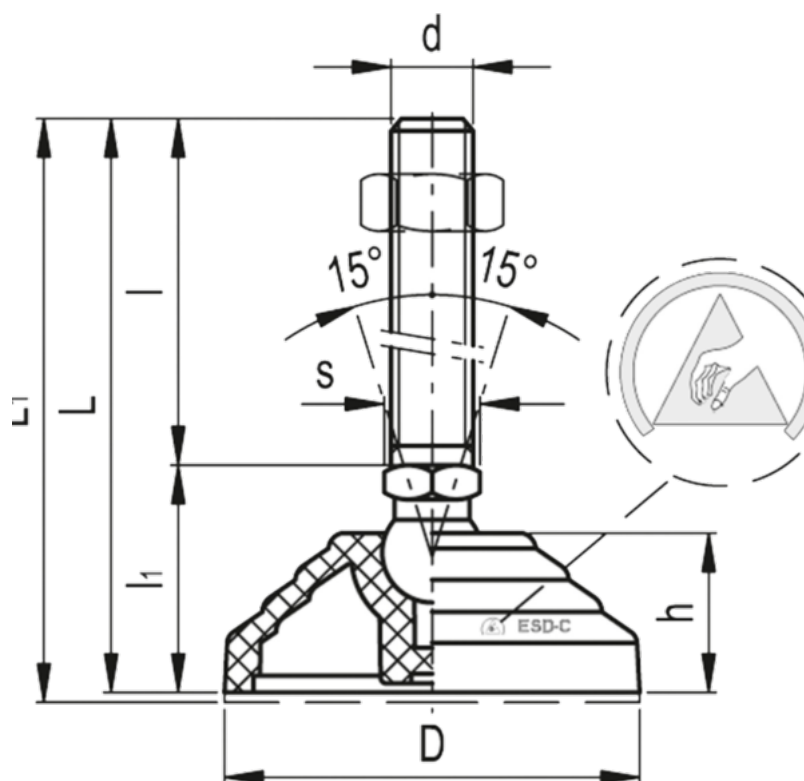

Articulation = 24	Max load = 28000
D = 125	s = 24
d = M16	Weight in (g) = 640
h = 46	
l = 158	
l1 = 67	
L = 225	
L1 = 228	